

Cooling Towers

HVACR Leadership Workshop by Eurovent Middle East

Eurovent Middle East

Association of the
**Heating, Ventilation,
Air-Conditioning and
Refrigeration Industry**
in the Middle East



Workshop Partners



Media partner:

climate control MIDDLE EAST
KEY PERSPECTIVES ON THE REGION'S HVACR INDUSTRY

Webinar recordings

Please subscribe to our YouTube Channel!



Agenda

1. Introduction: Guidebook Evaporative Cooling
2. Overview of advantages
3. Working principles
4. Critical aspects of design, installation, and operation
5. Case Study: Total Cost of Ownership
6. Cooling Tower Certification
7. Moderated Discussion

Introduction: Guidebook Evaporative Cooling

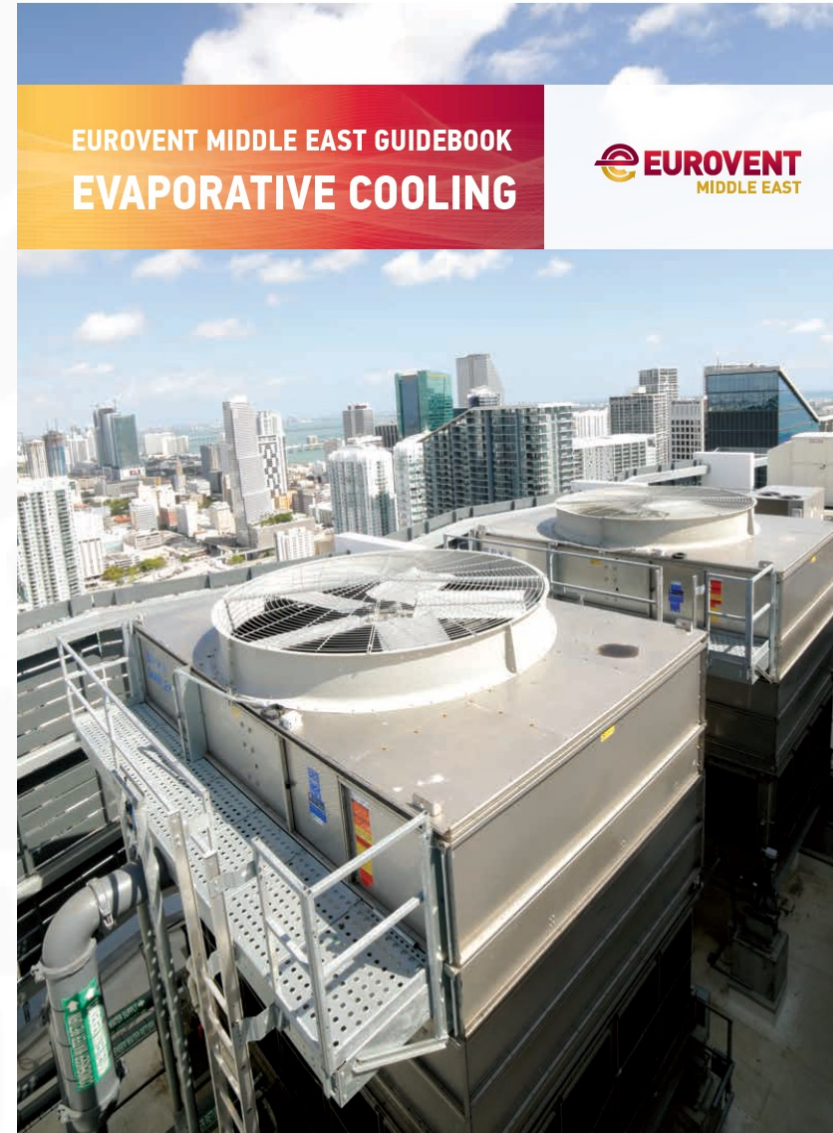

Guidebook 'Evaporative Cooling'

3. COOLING TOWERS

3. COOLING TOWERS

A large variety of evaporative cooling equipment exists, with different design principles, sizes and construction materials. While natural draft cooling towers depend on the height of the tower, and the associated differential air pressure between the top and the bottom to naturally induce air through the structure, mechanical draft cooling towers work with the support of fans, to create a forced or induced draft.

There are also many options in terms of materials of construction and the arrangements as the designer can choose the best combination of performance, energy usage and product life for each particular application. Finally, evaporative cooling products are available with a broad range of accessories such as regularly scheduled or sound attenuated packages.

3.1 OPEN CIRCUIT

Water from the heat source enters an inlet distribution and is distributed over the fill through a spray distribution arrangement. Simultaneously, ambient air is induced or forced through the tower, causing a small portion of the water to evaporate. This evaporator removes heat from the remaining water. The cooled water falls into the lower sump from where it is returned to the heat source. It is an open circuit as the water is cooled to a level not allowing for evaporation.



3.2 CLOSED CIRCUIT

The heat to be cooled is carried inside the tubes of the heat exchanger coil. A secondary system distributes water over the tubes of the coil. Simultaneously, air is forced or drawn over the coil causing a portion of the secondary water

2. ENERGY EFFICIENCY, WATER CONSUMPTION AND THE MIDDLE EAST ENVIRONMENT

2.1 ENERGY CONSUMPTION

Because more heat is removed by evaporation than by absorption, heat transfer evaporative cooling requires up to four times less energy for a given heat transfer capacity in a conventional condensation process. This means that as little as a quarter of the electrical energy used in dry cooling is needed.

Using cooling towers in HVAC systems not only reduces the energy consumption of the end-user water cooling loop, but also provides better indoor climate temperatures in the building, allows for much lower energy consumption in the outdoor coil, the outdoor fan, the most power consuming part of equipment in the system.

Effective heat transfer combined with lower air flow through the coil reduces evaporative cooling equipment's footprint when it comes to energy usage. Thus, by both application and design, evaporative cooling equipment saves energy and reduces emissions.

2.2 WATER CONSUMPTION

In any cooling system, there is a balance between usage of water and power to achieve the required cooling. This is sometimes referred to as the water-energy ratio. Evaporative cooling systems use the equivalent efficiency of latent cooling to dissipate large amounts of energy whilst using the lowest amount of water.

In regions with scarce water resources like in some parts of the Middle East, saving the water usage from evaporation at the cost of higher power consumption may seem preferable. However, in evaporative cooling systems, the water is recirculated and the water losses through evaporation are rather minimal. In the other hand, condensation must be given to the water that is required for the production of electrical power.



3.4 COUNTER FLOW

Warm process water from the heat source enters the spray system at the top of the cooling tower where it is distributed over the fill or heat transfer media. At the same time air is drawn or forced from below the fill. Because the water is travelling vertically down, and the air is passing vertically up through the fill they are in counter direction to each other, hence the term counter-flow.



3.5 CROSS FLOW

Warm process water from the heat source enters the water distribution system at the top of the cooling tower where it is distributed over the fill or heat transfer media. At the same time air is drawn from the sides of the coil through the fill. Because the water is travelling vertically down, and the air is passing horizontally across the fill, they cross each other in perpendicular directions, hence the term cross-flow.



3.6 INDUCED DRAFT

These cooling towers are characterized by the fan located in the discharge air stream, therefore inducing the air through the tower.



3.4 EVAPORATIVE COOLING IN THE MIDDLE EAST

3.4 EVAPORATIVE COOLING IN THE MIDDLE EAST

As a LOCAL CONDITIONS AND CLIMATE DATA

As the cooling towers cool water by evaporation, the wet bulb temperature (WBT) is the design set point parameter. Typically, the WBT in the region is more than 10°C lower than the dry bulb temperature (DBT), enabling lower water and coil temperatures to complete the air-cooled systems. The amount of evaporation is a function of the difference between DBT and WBT, and the heat load.

The larger the difference between these two temperatures are, the bigger the efficiency gains by evaporative cooling. For example, this means that water at hot summer days in Riyadh with an ambient dry bulb temperature of 42°C, evaporative cooling equipment can easily cool water down to a temperature of 14°C. How is that possible? The wet bulb temperature is 14°C for the period of 10 hours to 16°C. Certified evaporative cooling equipment can cool down to within 1°C of the given wet bulb temperature.

To understand the potential and requirements, it is important to look at the full climatic data of a specific location. Such data is provided by local meteorological stations and is also published regularly by AQHAQ.

KEY TAKEAWAYS

- Cooling towers are designed for specific wet bulb temperatures. To establish the correct wet bulb temperatures for any given location, refer to AQHAQ or local weather data.
- Evaporative cooling is always more energy efficient than dry cooling.
- Low evaporative cooling is projects over 100kW.
- Consult with manufacturers on the best plant layout.
- Incorrect plant design can lead to restrictions and significantly reduce plant's capacity.
- Hot maintaining systems regularly results in a loss of energy every day.
- Water treatment programmes are critical to maintain performance and avoid harmful bacteria and chemical accumulation.
- Comprehensive maintenance programmes save money.
- Quality should never be compromised by questions of cost. Remember, cheap is always more expensive.
- Independent third party certification is essential to avoid discrepancies between published performance data and actual performance.
- Energy-efficient products with CEI (Energy Efficient) certification do not require any further building up site.
- Energy certificates should be cross checked with an online database to ensure their validity.

DEFINITIONS

- This Guidebook provides a comprehensive glossary on page 27, which contains all specific terms you need throughout the text. Defining its meaning will give you a better understanding of the European content. An acronym list is also included for further explanation in the glossary and printed in course letters.

Guidebook 'Evaporative Cooling'



Guidebook 'Evaporative Cooling'



**BALTIMORE
AIRCOIL COMPANY**

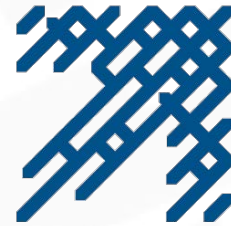

SPX



Guidebook 'Evaporative Cooling'

We appreciate your feedback!

office@eurovent.me

Evaporative Cooling Advantages

Mr Chukri Al Aani

Regional Sales Manager – MEA & Turkey
SPX Cooling Technologies Trading DMCC

What are your design goals?

- Comfort
- Efficiency
- Cost
- Reliability
- Sustainability
- All of the above



Copyright © 2021 SPX Cooling Technologies, Inc. All Rights Reserved

Water-Cooled System Advantages

- Evaluated Cost (Energy Use)
- Capacity/Comfort/Control (Water-cooled chillers capacity)
- Noise and Maintenance Time (No. of Fans & equipment)
- Smaller Footprint (No. of Chillers)
- Total Water Usage (Power Generation)

System Definition: Water-Cooled Chiller vs. Air-Cooled Chiller

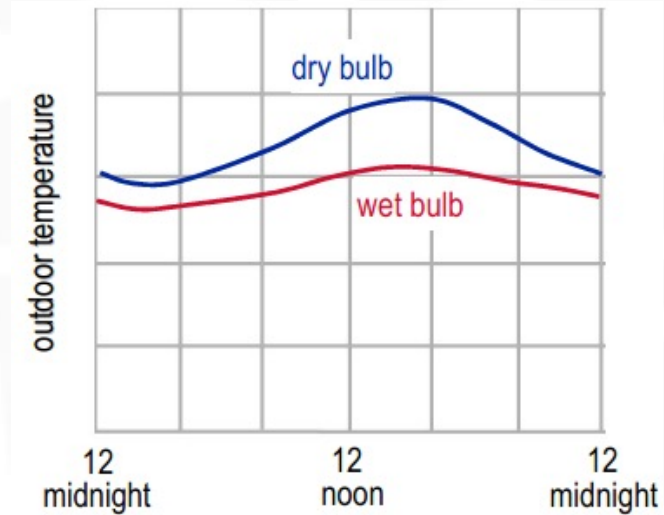
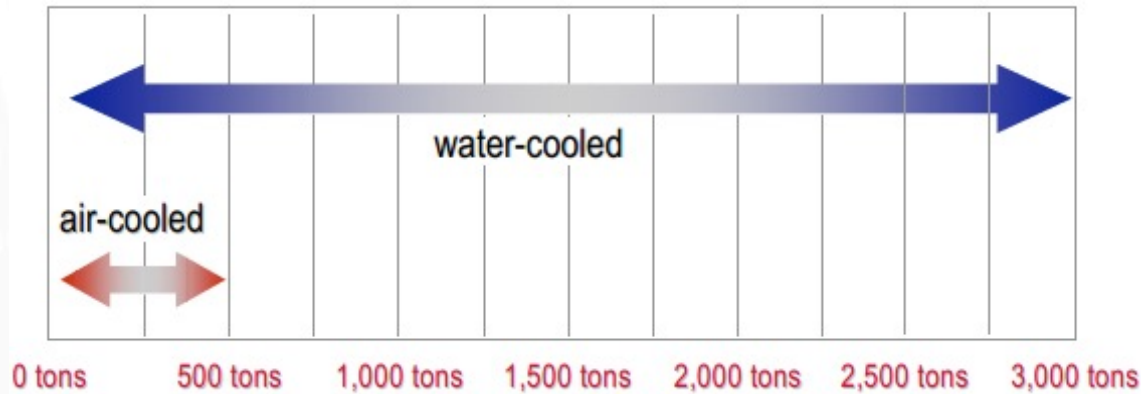

- **Water-cooled chiller has a larger capacity**
- **Utilisation of cooling tower requires extra piece of equipment, but allows us to cool below dry bulb temperature**

The Value of Evaporative Heat Rejection

Vs. Alternative Systems

Highest energy efficiency

- 50% less energy usage on typical application

Lower GHG Emissions

- Significantly lower; less than half of the CO₂ footprint

Comparable or lower water usage

- Up to 40% less water consumption (high water usage in power production)

Other User Benefits

- Less noise – 2 fans vs. 20 fans, typical
- Environmentally friendly materials – recycled PVC, less metal usage
- Space – 2 - 5X less space for heat rejection

Evaporative Cooling is Sustainable with Significant Environmental and Water Usage Benefits

Copyright © 2021 SPX Cooling Technologies, Inc. All Rights Reserved

Benefits of Evaporative Cooling

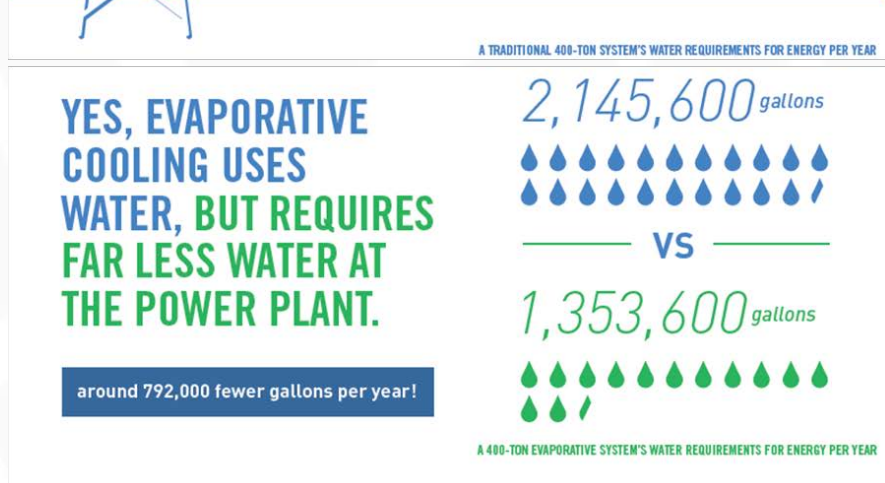
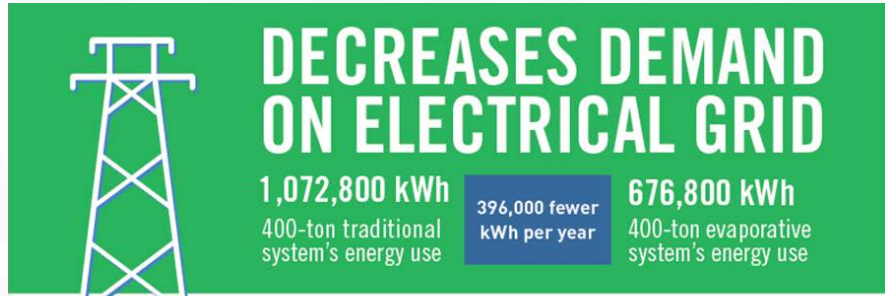
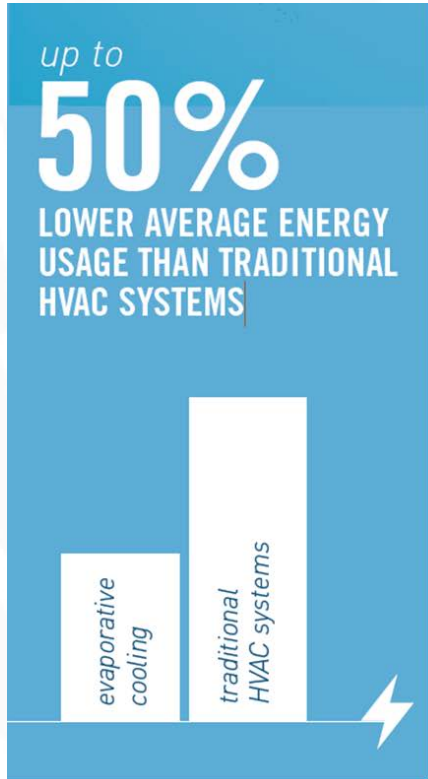

Source: Alliance to Prevent Legionnaires' Disease

Agenda

1. Introduction to Eurovent Middle East's Cooling Tower Guidebook
2. Evaporative Cooling: Overview of advantages
- 3. Evaporative Cooling: Working principles**
4. Critical aspects of design, installation, and operation
5. Case Study – Total Cost of Ownership
6. Cooling Tower Certification
7. Moderated Discussion

Evaporative Cooling: Working Principles

Mr Jai Kawrani

Application Manager – Middle East & India

Baltimore Aircoil Middle East LLC

Methods of Cooling

AIR COOLED



Dependent on ambient
(dry bulb)
temperature

EVAPORATIVE COOLED



Evaporative cooling, dependent
on wet bulb temperature

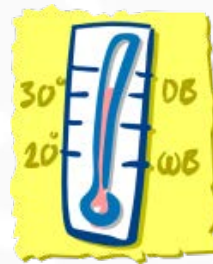

HYBRID, WET/DRY, ADIABATIC

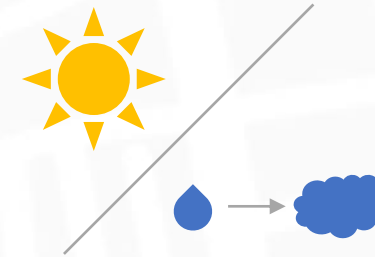

Dependent on both
dry bulb and wet bulb
temperatures



Typical $>10^{\circ}\text{C}$ difference between wet bulb and dry bulb

Traditional Water-Cooled HVAC System

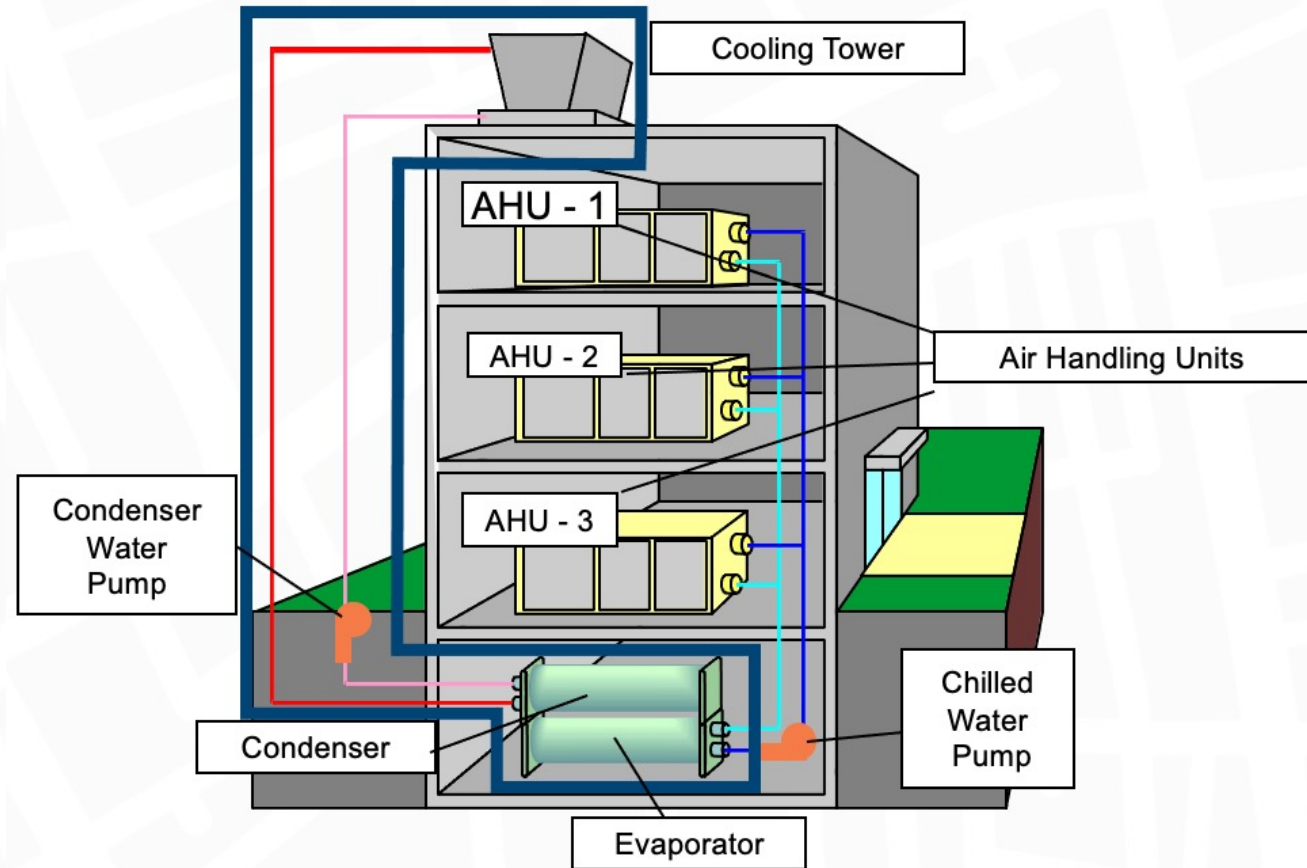

Principles of Evaporative Cooling

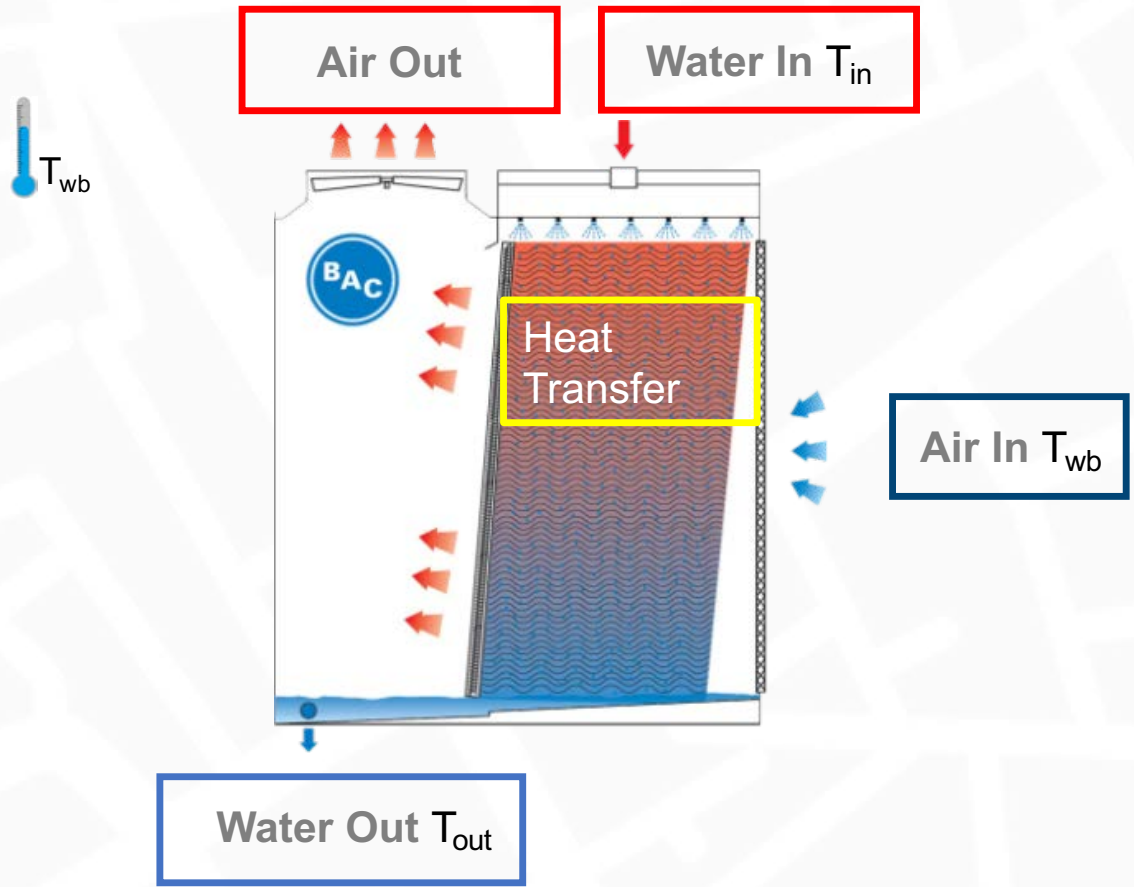

T_{in}	: Water Inlet Temperature (°C)
T_{out}	: Water Outlet Temperature (°C)
T_{wb}	: Wet Bulb Temperature (°C)
Range	= $T_{in} - T_{out}$
Approach	= $T_{out} - T_{wb}$

Principles of Evaporative Cooling

Heat transfer

- Sensible
- Latent



For every kilogram of water evaporated, 2256 kilo Joule of heat is removed from the water (whereas with 1 Kilogram of air, the heat removed is about 1 kilo Joule per deg C)

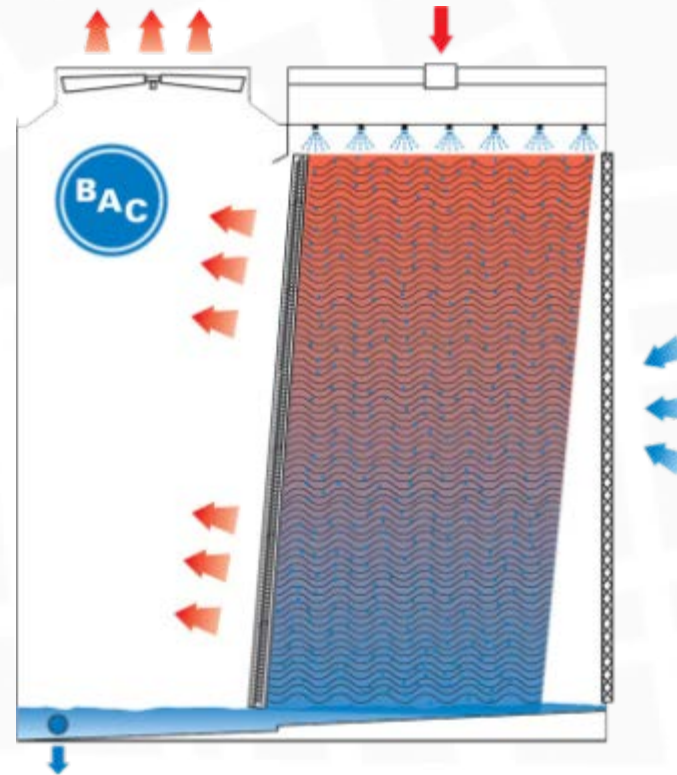

Principles of Evaporative Cooling

Dry Bulb
Wet Bulb
Enthalpy
Moisture Content

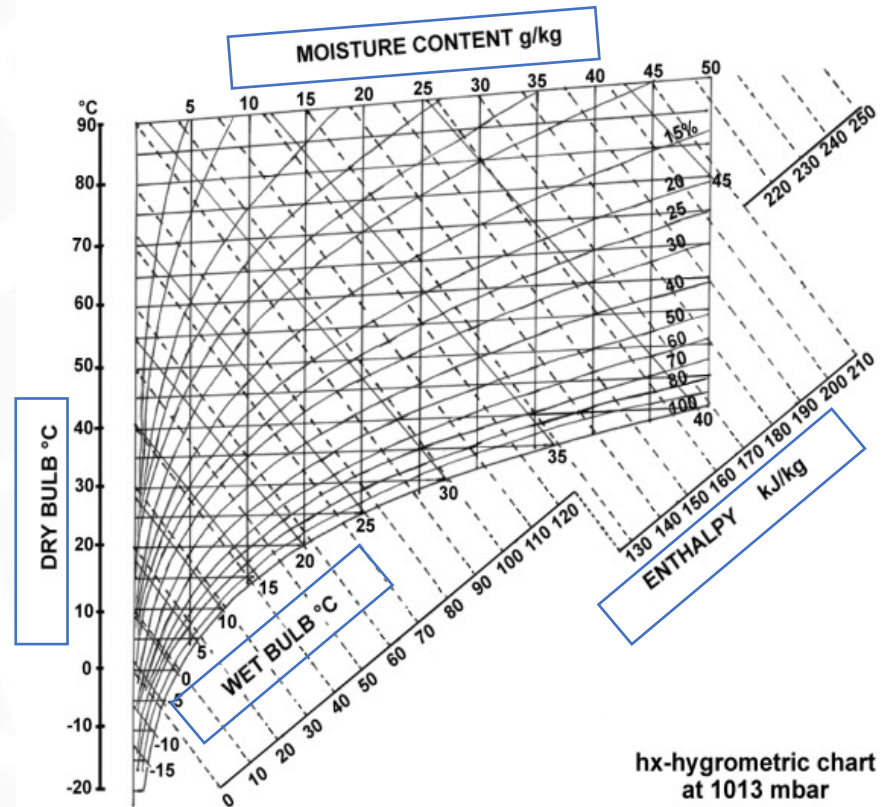

Principles of Evaporative Cooling

Air gets saturated

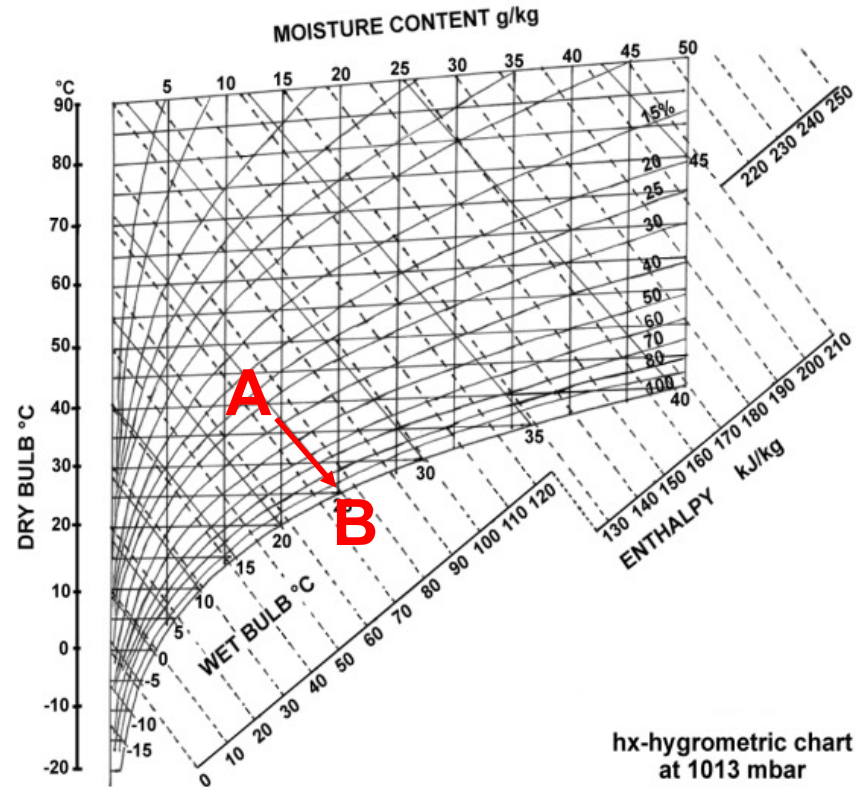
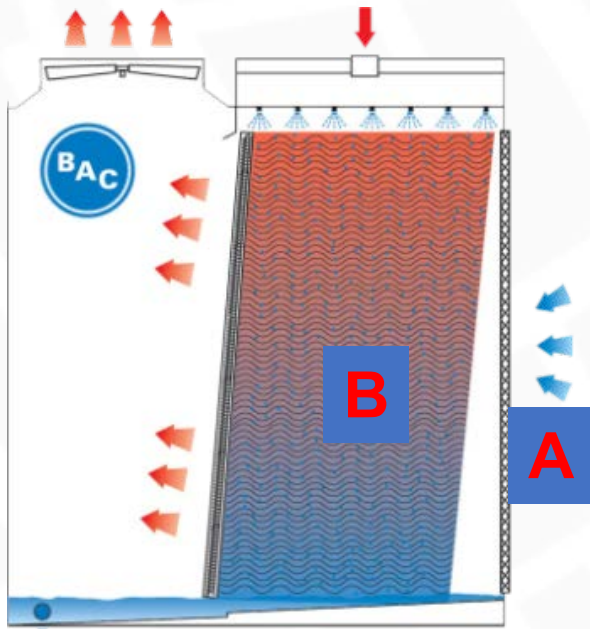

Principles of Evaporative Cooling

Air heats up

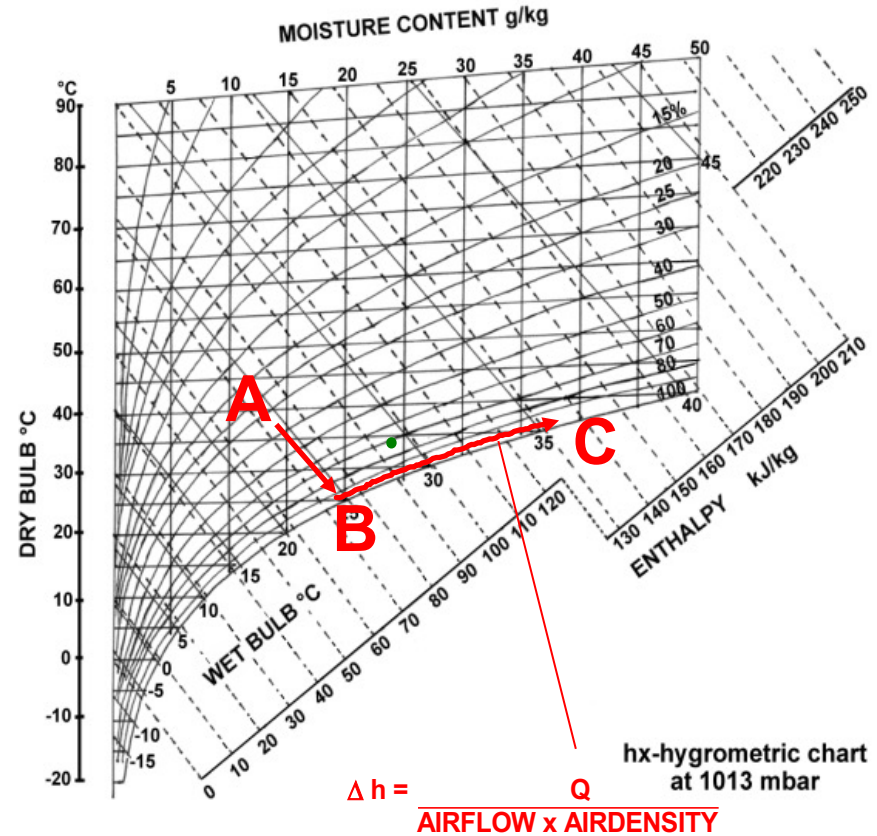
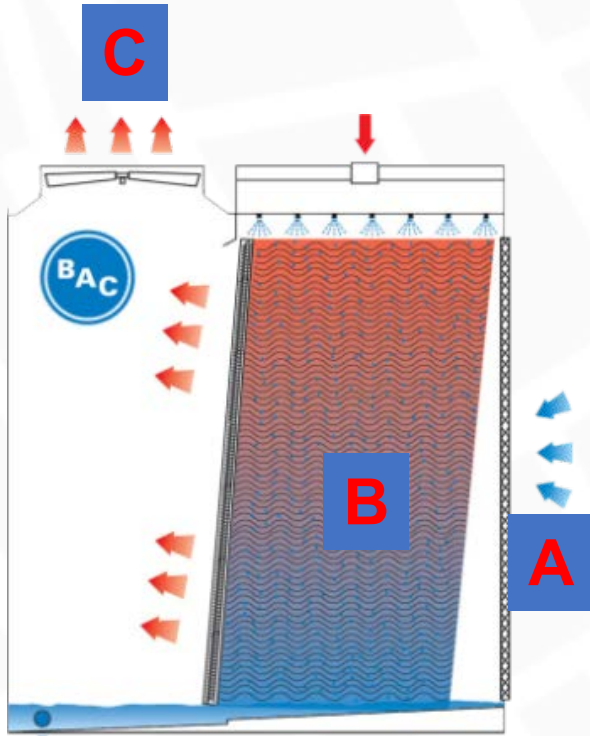

HVAC System

$$\text{kW} = \text{flow (lps)} \times \text{delta T} \times 4.186$$

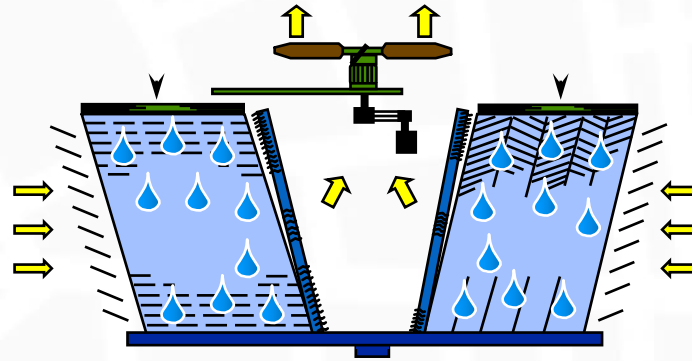

- The cooling tower does not control the range or flow
- The cooling tower only controls the approach



HVAC System Optimisation



10°C Approach
10.1°C Range
4300kW
Tin = 41.1°C
Tout = 31.0°C

22kW Fan motor





6°C Approach
5°C Range
2100kW
Tin = 32°C
Tout = 27°C

22kW Fan motor



3.5°C Approach
2.5°C Range
1100kW
Tin = 27°C
Tout = 24.5°C

22kW Fan motor



Constant

- ◆ Flow: 100.9 l/s
- ◆ **Wet bulb: 21°C**

Variable

- ◆ Range

Same Cooling Tower can handle different capacities

HVAC System Optimisation

10°C Approach

T_{in} = 36°C
T_{out} = 31°C

15kW Fan motor



6°C Approach

T_{in} = 32°C
T_{out} = 27°C

22kW Fan motor



2°C Approach

T_{in} = 28°C
T_{out} = 23°C

45kW Fan motor

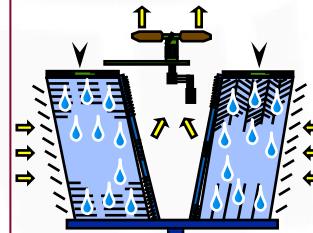

Constant

- ◆ Flow: 100 l/s
- ◆ Range: 5°C
- ◆ Heat rejection: 2100kW
- ◆ Wet bulb: 21°C

Variable

- ◆ Approach

Design for smaller Approach with a larger Cooling Tower → reduces the Chiller size

HVAC System Optimisation

$Lift(F) =$
 $Leaving\ CDW\ T - Leaving\ CHW\ T$

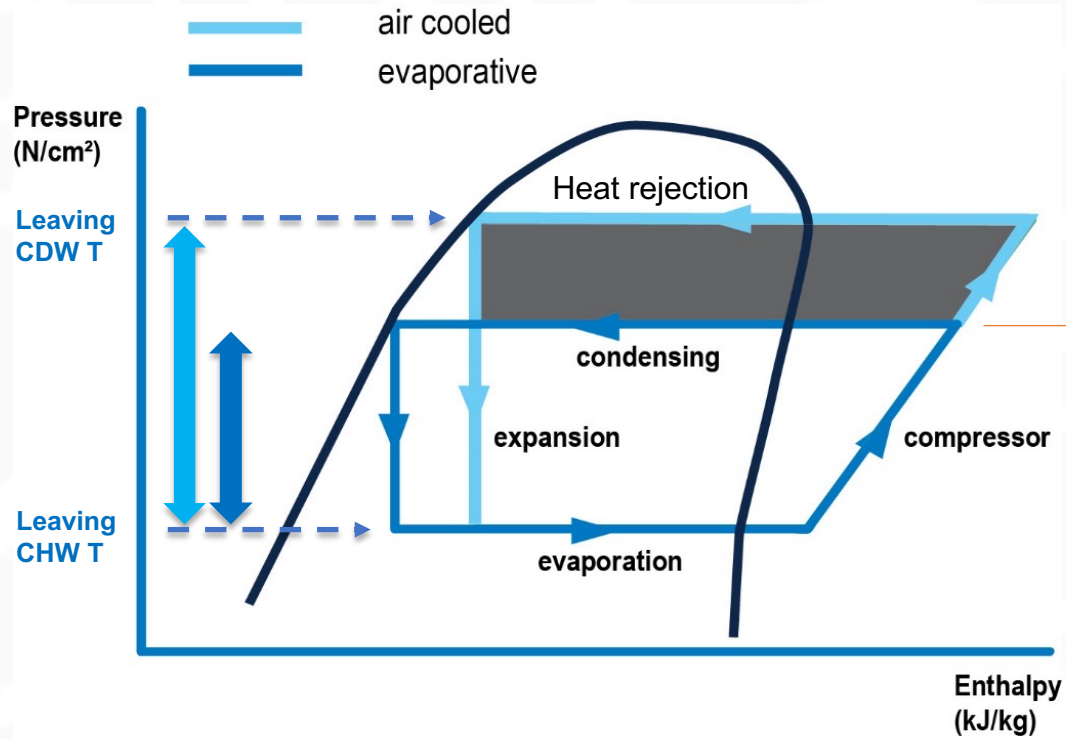

For every 1°C decrease in condenser water → decreases the energy usage of the chiller by approx 3%

Agenda

1. Introduction to Eurovent Middle East's Cooling Tower Guidebook
2. Evaporative Cooling: Overview of advantages
3. Evaporative Cooling: Working principles
- 4. Critical aspects of design, installation, and operation**
5. Case Study – Total Cost of Ownership
6. Cooling Tower Certification

Critical Aspects of Design, Installation and Operation

Mr Chukri Al Aani

Regional Sales Manager – MEA & Turkey
SPX Cooling Technologies Trading DMCC

Cooling Towers Design

- **Space available**
- **Obstacles/other heat sources surround the site**
- **Noise requirements**
- **Plume**
- **Cooling tower maintenance**
- **Types of cooling towers**

Copyright © 2021 SPX Cooling Technologies, Inc. All Rights Reserved

Interference

It is wet bulb at the tower air inlet that matters

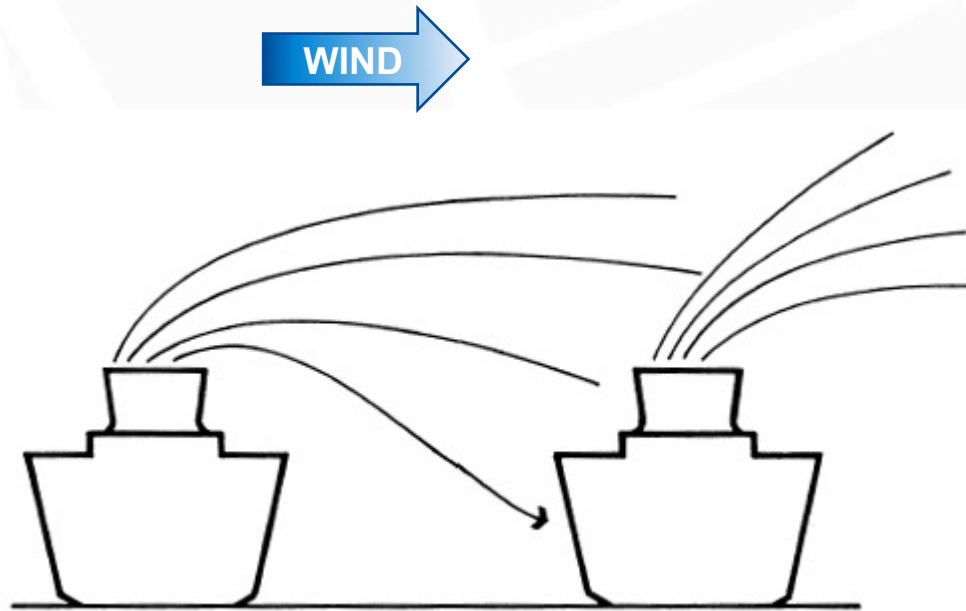

Local heat sources upwind of the cooling tower can elevate the wet bulb temperature of the air entering the tower, thereby affecting its performance. This could be an existing cooling tower, or another source of heat. This phenomenon is called “interference.”

Space & Obstacles

When siting a cooling tower next to a building, wind direction and discharge elevation need to be considered to avoid recirculation.

The higher building elevation, and low discharge velocity encourages the air back down towards the low-pressure area around the air inlet, created by the high inlet velocity of a forced draught configuration.

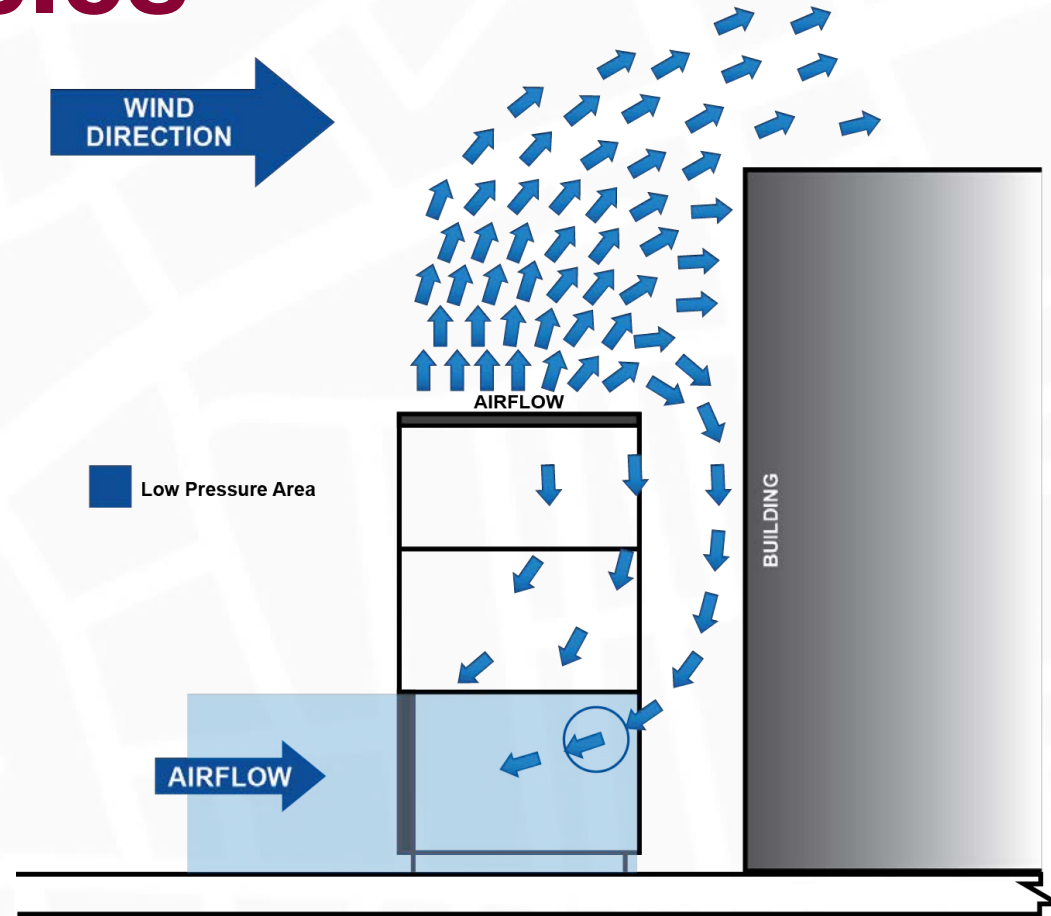

Primary Measurement Locations/ Breakout Sources

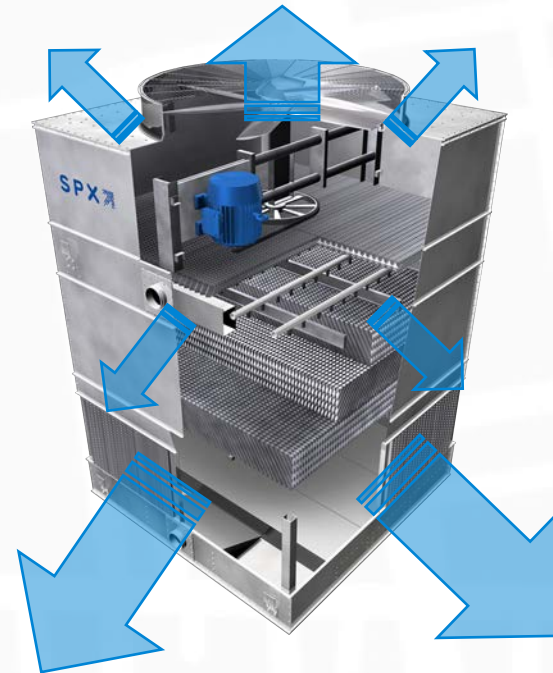

Copyright © 2021 SPX Cooling Technologies, Inc. All Rights Reserved

Primary Measurement Locations Breakout Sources



Counterflow

- Air inlets & fan discharge primary measurement locations
- Falling water noise produces higher frequencies at the air inlets, and on an induced draft tower this is typically on all 4 sides
- Again, noise breakout will also occur through the casing, although much less than fan discharge or air inlet

Crossflow

- Air inlets & fan discharge primary measurement locations.
- Because there is no falling water noise, air inlet noise is less prominent than a counterflow equivalent – lower frequency.
- Noise breakout will also occur through the casing, although much less than fan discharge or air inlet.

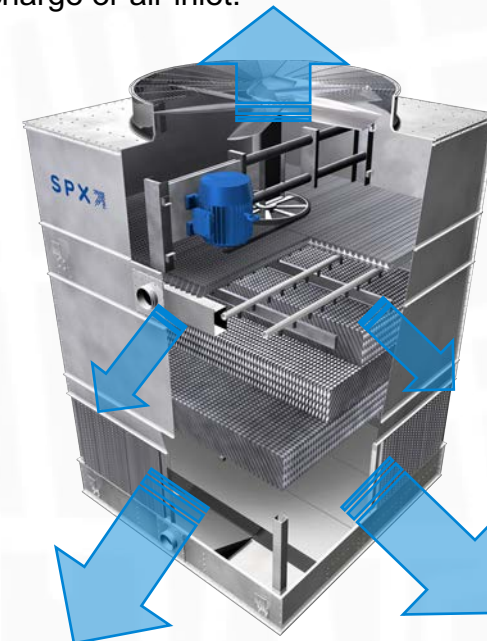

Copyright © 2021 SPX Cooling Technologies, Inc. All Rights Reserved

Cooling Tower Noise

- Where is cooling tower sound important?
 - Where people will be to hear it!
 - Varies with every installation
 - Considerations
 - Near field: occupational safety
 - Far field: property line sound levels

Properly defining sound requirements is critical to making sound decisions.



Sound Success Strategies

- Understand the project specific-requirements for noise
 - Where and what is the noise sensitive area
 - What options are there for where/how the tower can be oriented
 - Are there particular times of day that are more noise sensitive? – Running the fans at a lower speed at night will reduce noise
 - 50% speed = 12dB(A) approx
 - 66% speed = 8dB(A) approx

Cooling Tower Noise Treatment

- Re-orientation of tower
- Lower air inlet height (typically field erected only)
- Splash attenuation mats (counterflow only)
- Variable speed gearbox
- Incorporated and/or external barriers
- Low noise fan
- Inlet/outlet attenuators
- Ultra quiet fan, super low noise fan, ...

Consider options to reduce noise in order of cost

Plume



Copyright © 2021 SPX Cooling Technologies, Inc. All Rights Reserved

Induced Draft Crossflow Tower

- Induced draft towers develop less total static pressure than forced draft towers.
 - more sensitive to the impact of external air losses
 - ***air inlet clearances must be governed by their potential to add system air losses***

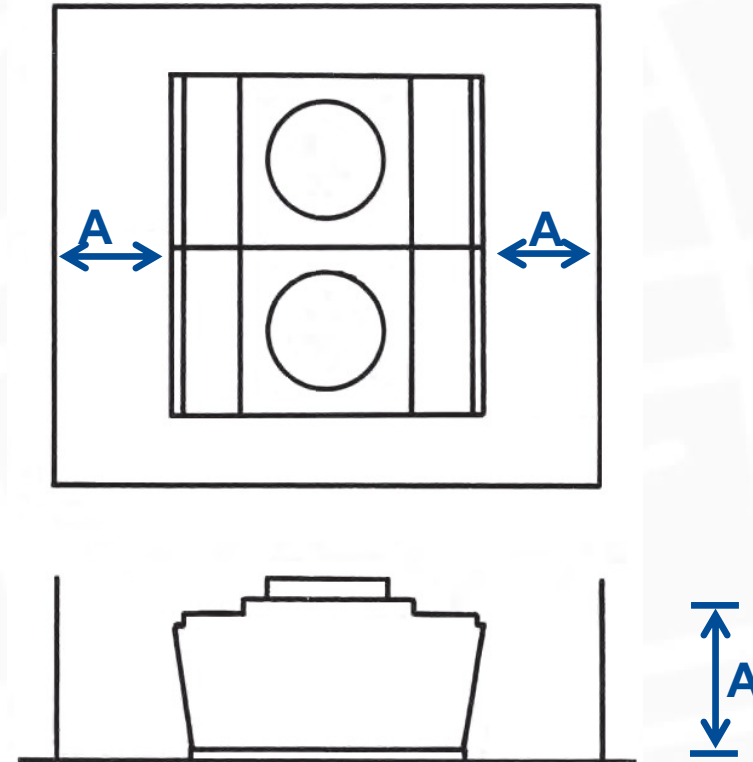

Rule applies to 1 or 2 cell towers only. For towers with more than 2 cells, add 15% to the dimension for every extra cell

Maintenance Access: Induced Draft Crossflow



Induced Draft Counterflow Tower

- Because this distance is so much smaller typically on an induced draft counterflow, maintenance access becomes the deciding factor, not airflow.
- Typical maintenance access for this type of tower would be a minimum of 1000mm. Under normal circumstances, more than this would be given to allow for comfortable working.

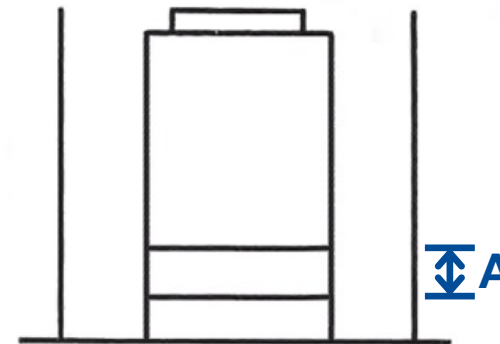
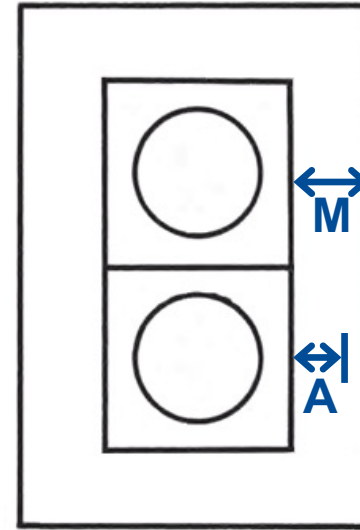

Rule applies to 1 or 2 cell towers only. For towers with more than 2 cells, add 15% to the dimension for every extra cell

Maintenance Access: Induced Draft Counterflow

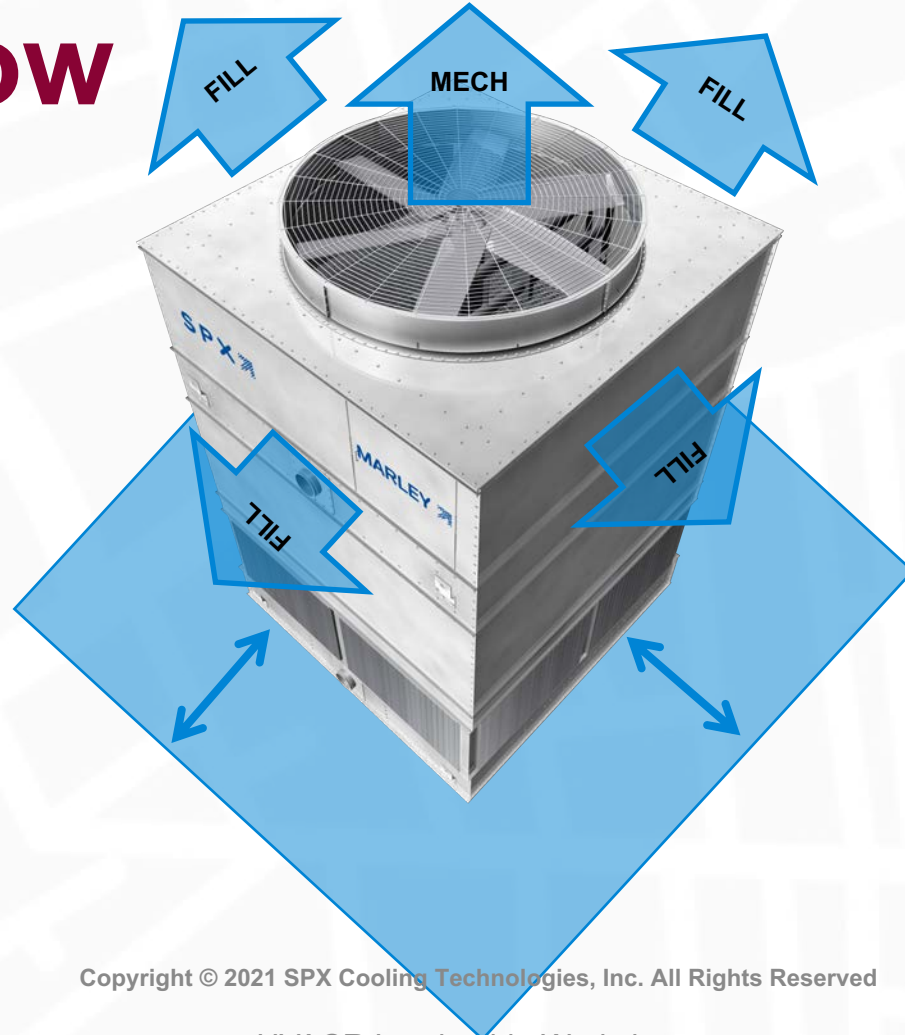

Copyright © 2021 SPX Cooling Technologies, Inc. All Rights Reserved

Agenda

1. Introduction to Eurovent Middle East's Cooling Tower Guidebook
2. Evaporative Cooling: Overview of advantages
3. Evaporative Cooling: Working principles
4. Critical aspects of design, installation, and operation
- 5. Case Study – Total Cost of Ownership**
6. Cooling Tower Certification
7. Moderated Discussion

Case Study: Total Cost of Ownership

Mr Rafael Van Eijcken

General Manager - Middle East, Turkey and India

Baltimore Aircoil Middle East LLC

***“If you want different results,
do not do the same things!”***

— Albert Einstein

Climate Change/ Global Warming

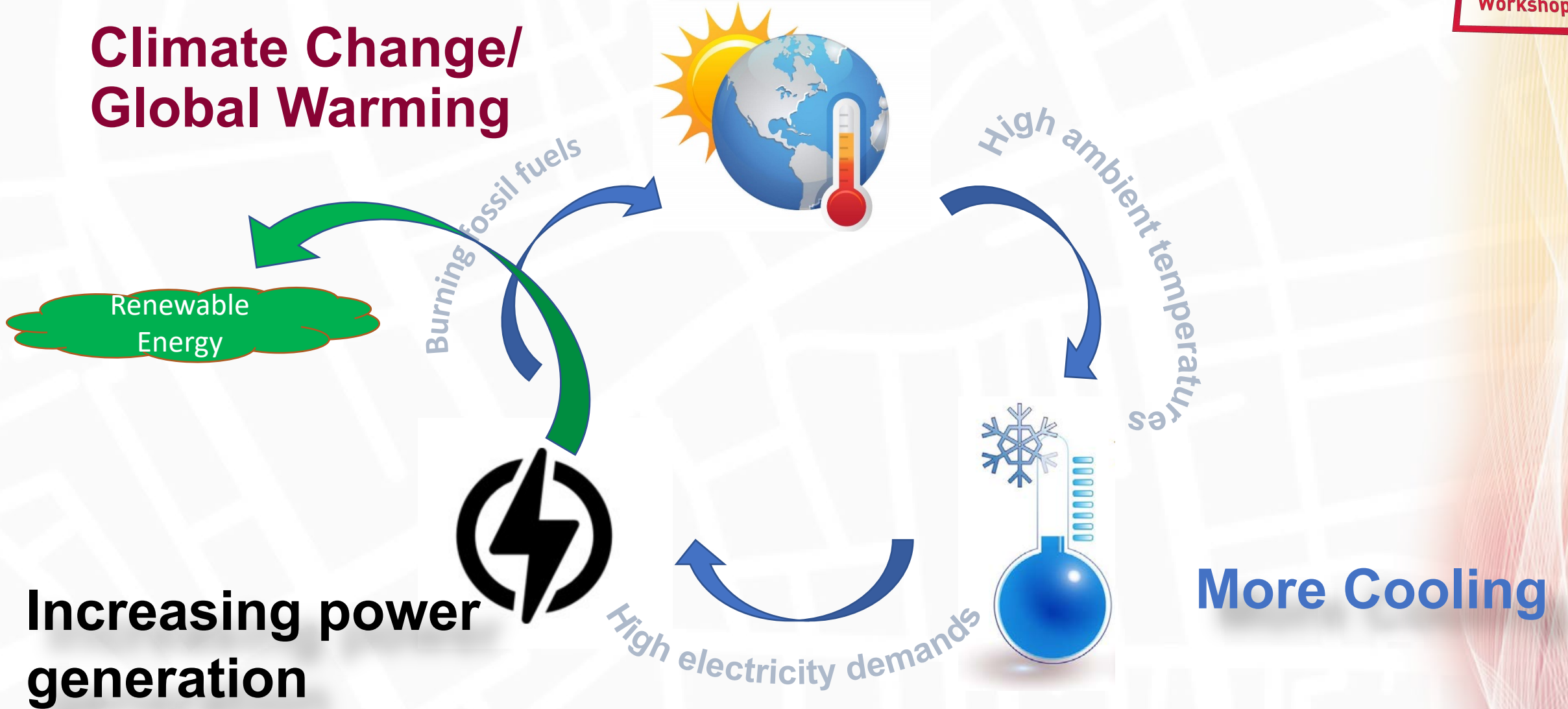

**Increasing power
generation**

More Cooling

Climate Change/ Global Warming

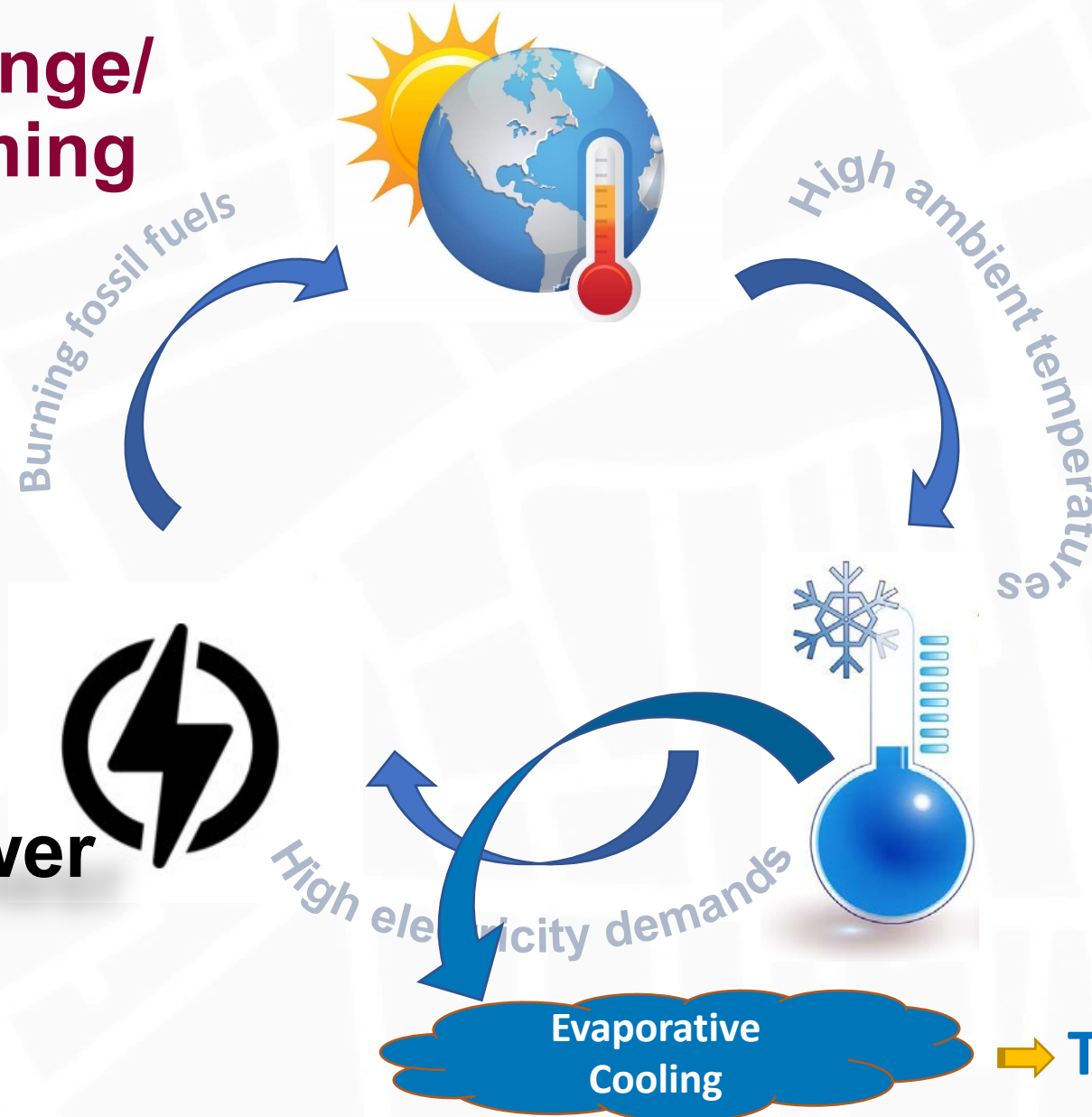

**Increasing power
generation**

Example: Typical HVAC System

Air-Cooled System →

Water-Cooled System →

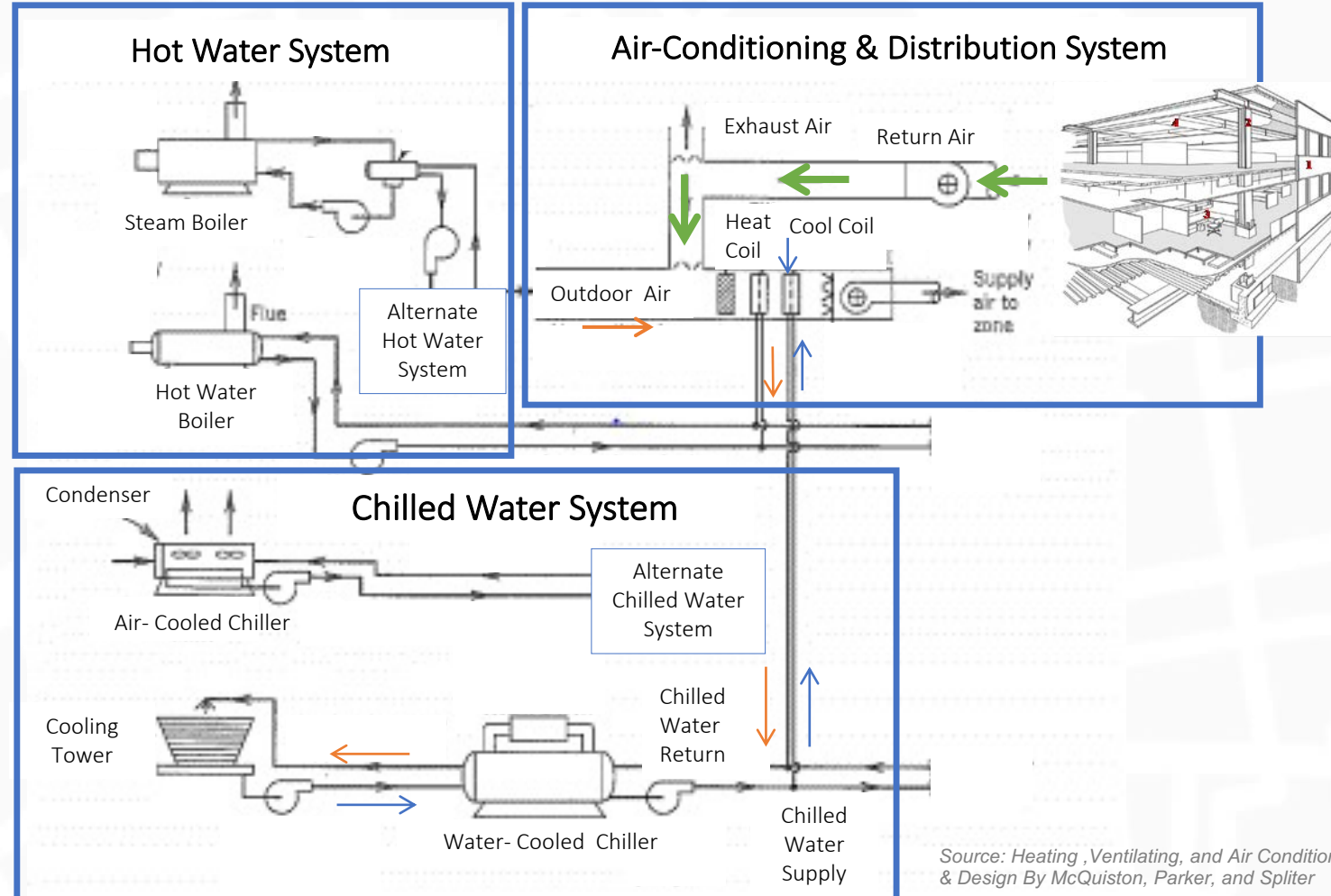

Source: Heating, Ventilating, and Air Conditioning Analysis & Design By McQuiston, Parker, and Spitzer

Air-Cooled vs Water-Cooled Heat Rejection

AIR-COOLED SYSTEM		WATER-COOLED SYSTEM	
1.	Design day is based on DRY bulb temperature	Design day is based on WET Bulb temperature	
2.	Larger outdoor technical footprint (more surface area)	<u>Smaller</u> outdoor technical footprint	
3.	Higher energy consumption	Lower energy consumption	
4.	Higher noise emissions (many small fans)	Lower noise levels	
5.	Consumes no water, at site (significant water usage at power plant)	Consumes water (Evaporative cooling) – TSE water	

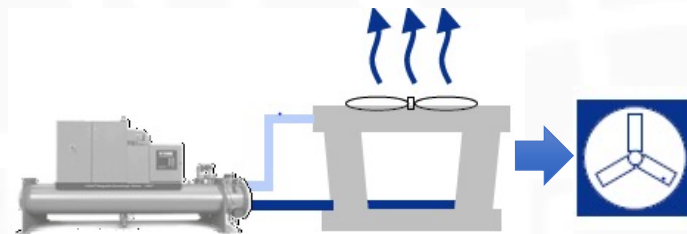
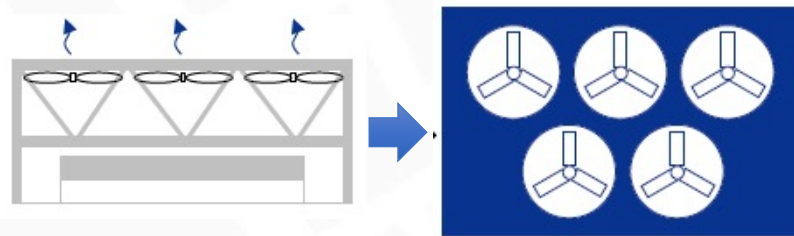

Air-Cooled vs Water-Cooled Heat Rejection

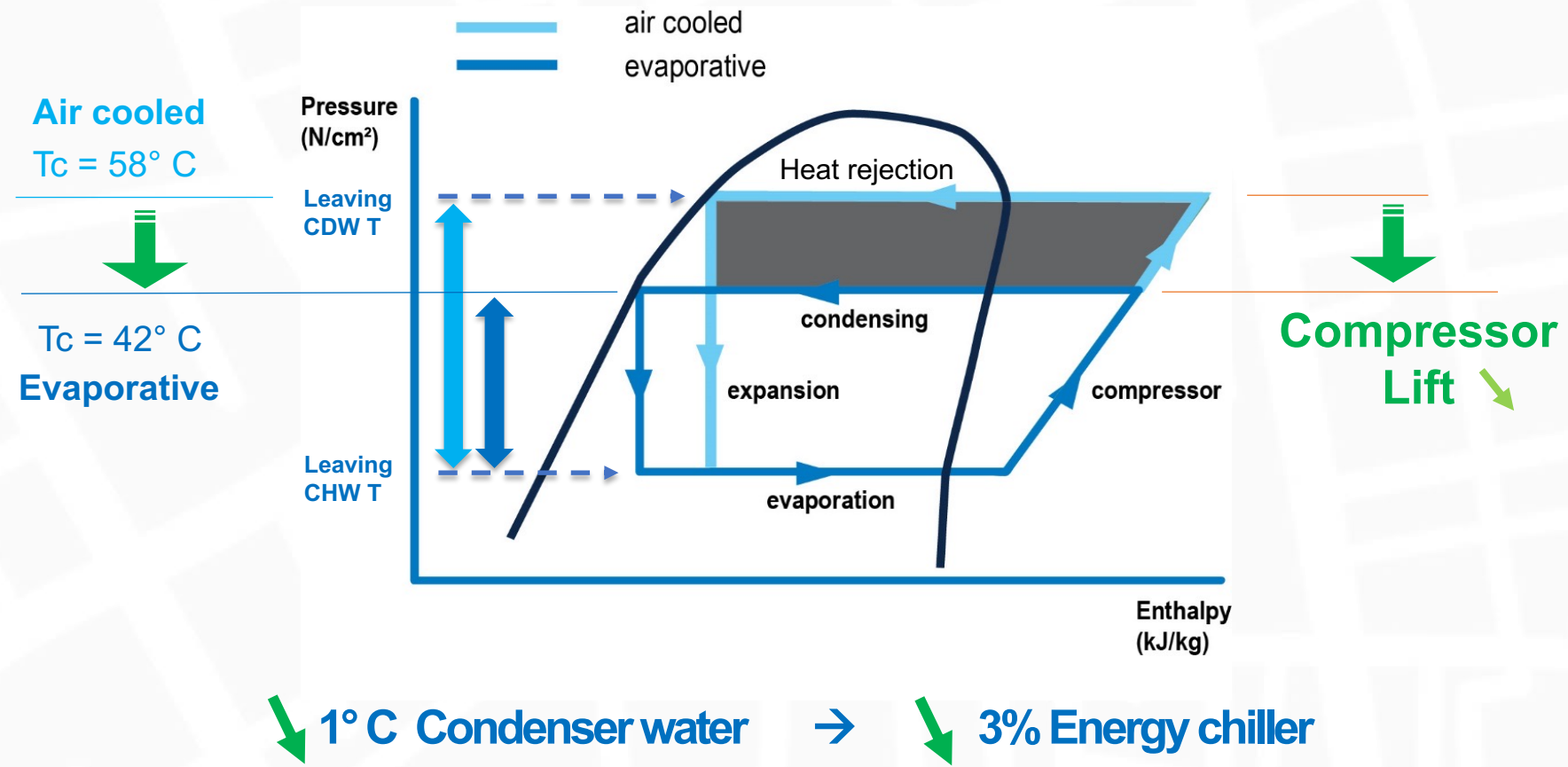

Evaporative Cooling in HVAC

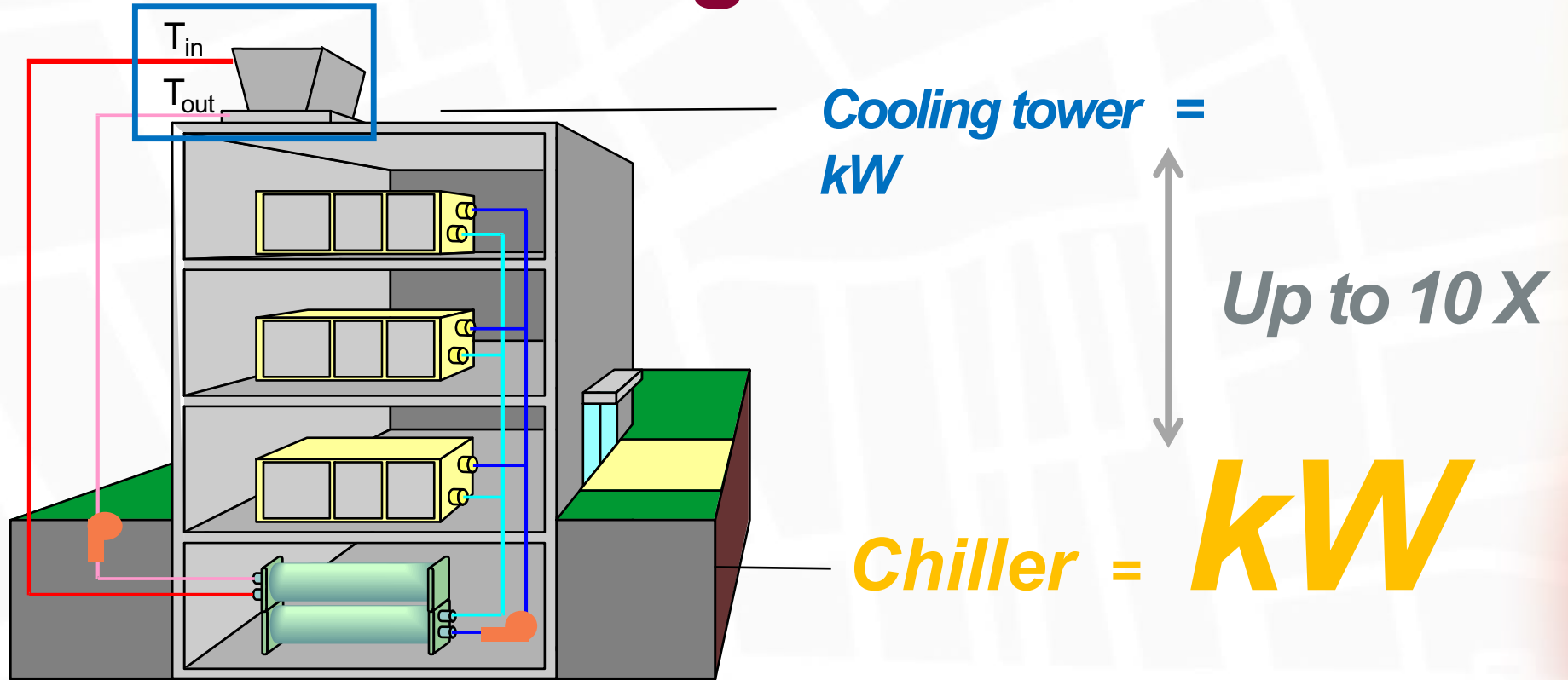

Chiller is the **MAIN** energy consumer in an HVAC system

Annual Operating Cost

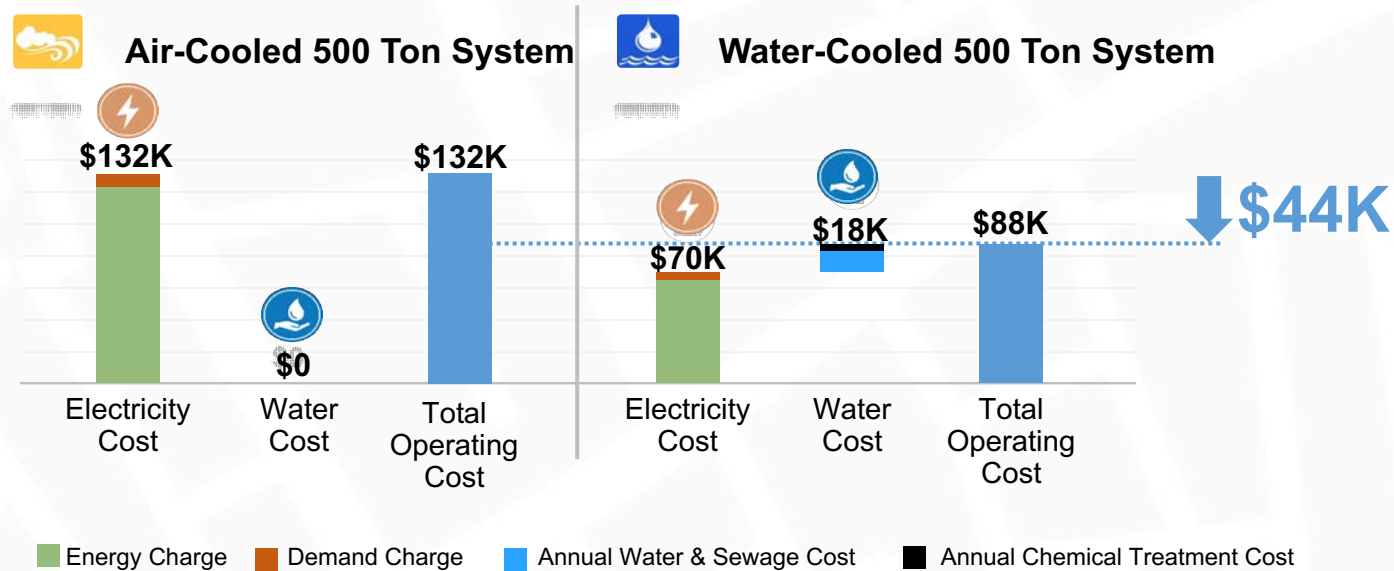

Water-Cooled Advantage:

- Savings of \$44,000 annually
- 48% Energy Savings
- 33% savings on annual operating costs

Assumptions:
 Energy rate \$0.103/kWh. Demand Charge \$13.44/kW. Water rate \$2.9/1000gal.
 Sewage rate \$5.3/1000gal. Hrs of Operation (IPLV) 4380.
 Considered system cleaning equal for systems as both HEX open to atmosphere

System Total Cost of Ownership

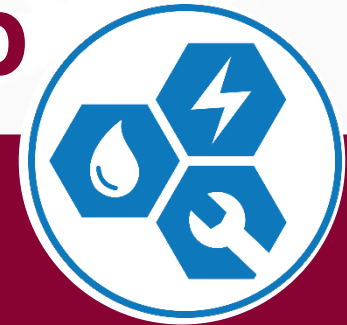

500 Ton System Cost	Equipment & Install	Annual Operating	Avg. Life*
Air-Cooled System	\$188K	\$ 132K	15-20 years
Water-Cooled System	\$ 242K	\$ 88K	20-30 years

* Selecting Chillers, Chilled Water Systems by David Grassl. <https://www.csemag.com>

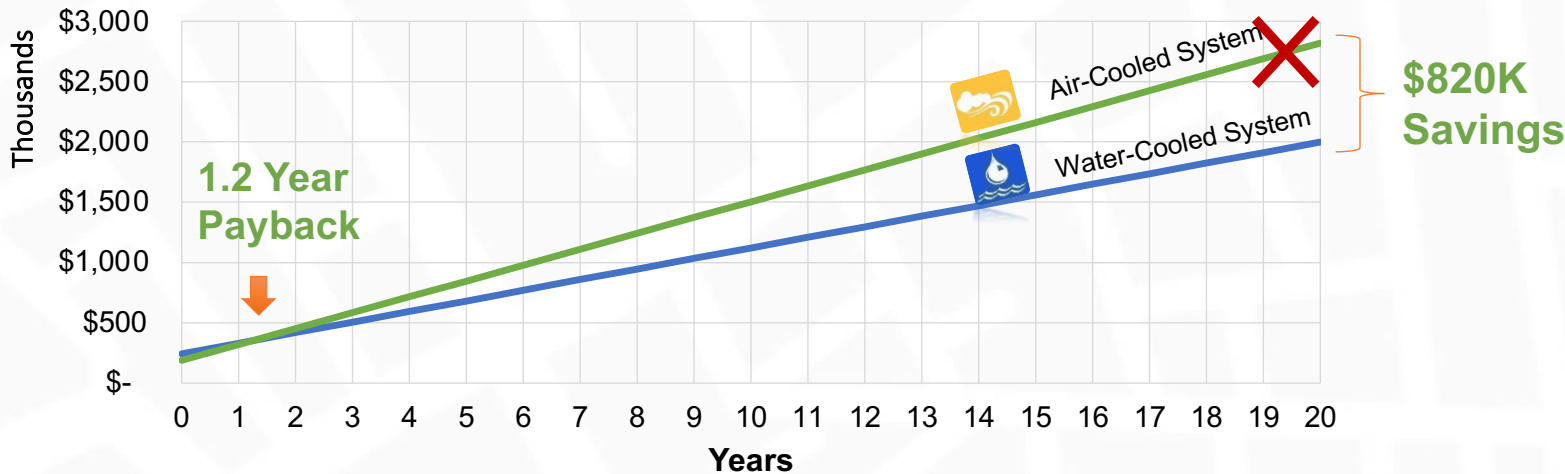

Water-Cooled Advantage:

- Payback Period of 1.2 years
- Life span of Water-Cooled > than Air-Cooled
- Total savings of ~\$820K at the end of 20 years

Important Note:

Indirect costs linked to additional (valuable) spacing requirement and Sound reducing barriers/technologies can be very significant !!!

Benefits: Evaporative Cooling



Lowest
Energy Cost



Lowest
Operating Cost



Lowest
Installation Cost
&
Easy Transportation



Lowest
Environmental
Impact

Agenda

1. Introduction to Eurovent Middle East's Cooling Tower Guidebook
2. Evaporative Cooling: Overview of advantages
3. Evaporative Cooling: Working principles
4. Critical aspects of design, installation, and operation
5. Case Study – Total Cost of Ownership
- 6. Cooling Tower Certification**
7. Moderated Discussion

Cooling Tower Certifications

Mr Chukri Al Aani

Regional Sales Manager – MEA & Turkey

SPX Cooling Technologies Trading DMCC

Cooling Technology Institute (CTI)

The CTI establishes **standard testing and performance analysis systems and procedures** for cooling technologies. It also encourages and supports cooperative research to improve cooling technology and efficiency for the long-term benefit of the environment.

CTI STD-201

- The standard sets forth a program whereby CTI will certify that all models of a line of evaporative heat rejection equipment offered for sale by a specific manufacturer will perform thermally in accordance with the manufacturer's published ratings.
- Applies to Mechanical Draft Evaporative Heat Rejection Equipment such as Open Circuit Cooling Towers, Closed Circuit Cooling Towers and Evaporative Refrigerant Condensers.



Eurovent Certification and CTI Partnership

ECC – CTI Memorandum of Understanding Mutual recognition Eurovent – CTI

“CTI and ECC endeavor to work together in the area of cooling tower certification in an effort to advance the certification programmes of both groups, be it therefore resolved, that CTI and ECC pledge to work cooperatively on all matter of mutual interest in the area of cooling tower certification.”

- Europe
- Middle East
- India

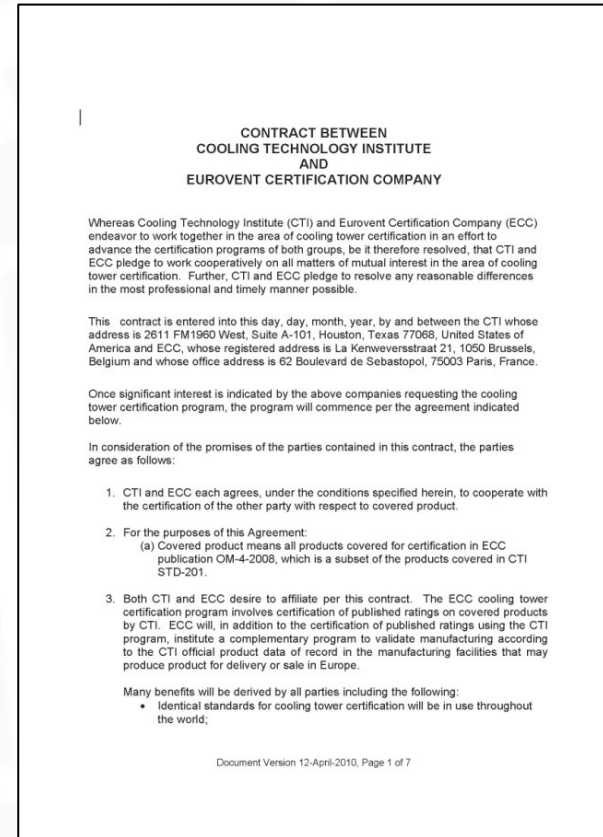

Scope of the Certification

General Purpose:

- Encourage honest competition
- Assure correctly rated equipment on the market
 - Separate and specific certification programmes for each product type
 - Product performance tests through an independent third-party
 - Application and participation open to all manufacturers

Copyright © 2021 SPX Cooling Technologies, Inc. All Rights Reserved

Initial Qualification Test

- **Thermal Performance Test per CTI ATC-105 Test Code**
 - Preparation per CTI FSP-156 Pretest Bulletin
 - Equipment Operation per CTI ATC-105 Test Code
 - Test Instrumentation per CTI ATC-105 Test Code
 - CTI owned flow measurement device
- **Capability Calculated Using Published Ratings**
 - Compares Measured Performance with Predicted Performance
 - 95% Minimum Capability Required to Pass Test
- **Verification of Physical “Data of Record”**
 - Inspection of Tower
 - Dimensional Comparison

Copyright © 2021 SPX Cooling Technologies, Inc. All Rights Reserved

Adding to System Design Performance/Efficiency

Cooling Towers Joins the Certified Product Performance Programme from Eurovent Certita Certification

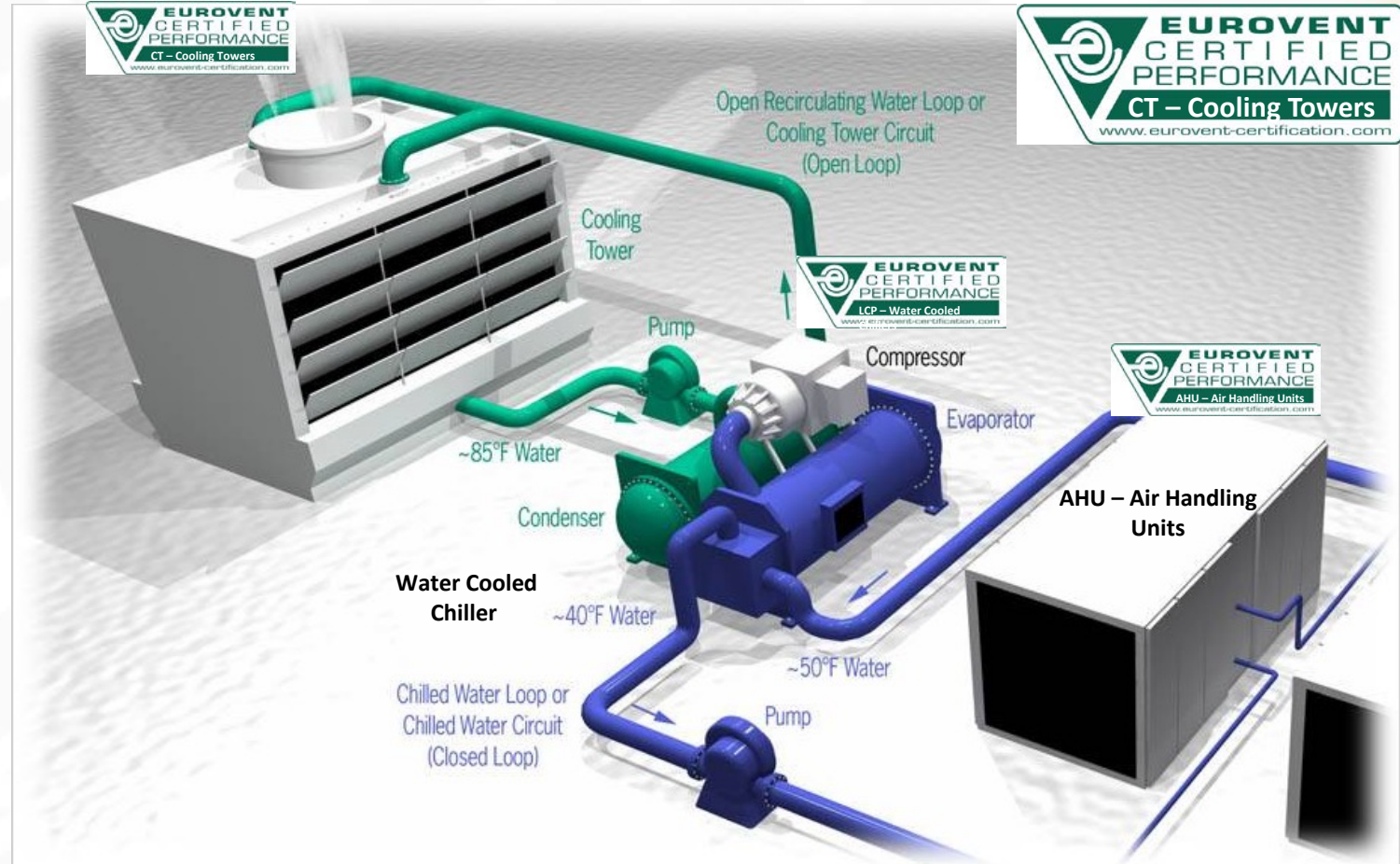

Formula For Success: Certified Efficient Products, Optimised System Designs, & Professional Installations



Some key issues:

- Air Recirculation
- Noise Amplification
- Control Strategy
- Poor Installation
- Regular Maintenance
 - Cleaning!

Copyright © 2021 SPX Cooling Technologies, Inc. All Rights Reserved

Verified performance:

